

VOGUE

Cutter

Instruction manual



(NL) Snijder	5
Handleiding	
(FR) Trancheuse	8
Mode d'emploi	
(DE) Schneider	11
Bedienungsanleitung	

(IT) Taglierina	14
Manuale di istruzioni	
(ES) Cortadora	17
Manual de instrucciones	
(PT) Cortador	20
Manual de instruções	

Model • Modèle • Modell • Modello • Modelo • Malli:
DB343 / DB344 / DB345

Safety Tips

- To get the best performance and service life from your product, please read and comply with these instructions.
- Clean the product thoroughly before and after each use.
- Minimize the use of alkaline cleaners as they may cause pitting and dulling of the finish.
- **Remember that the blades are VERY SHARP! Be careful when handling and operating the machine. Always keep your hands away from the blades.**

















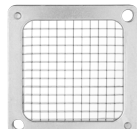
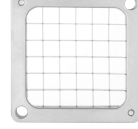

Product Description

DB343 - Fruit/Vegetable Wedge Cutter
 DB345 - Vegetable Dicer with 9.5mm Blade

DB344 - Potato Chip Cutter

Parts List



Pack contents		Optional parts (not supplied)		
 <p>Model: DB343</p>	 <p>6 section blade assembly</p>	 <p>8 section blade assembly</p>	 <p>10 section blade assembly</p>	
	 <p>6 section pusher block</p>	 <p>8 section pusher block</p>	 <p>10 section pusher block</p>	
 <p>Model: DB344</p>	 <p>9.5mm blade assembly</p>	 <p>6mm blade assembly</p>	 <p>12.5mm blade assembly</p>	
	 <p>Pusher block for 9.5mm</p>	 <p>Pusher block for 6mm and 12.5mm</p>		

Pack contents		Optional parts (not supplied)	
 <p>Model: DB345</p>	 <p>9.5mm blade assembly</p>	 <p>6mm blade assembly</p>	 <p>12.5mm blade assembly</p>
	 <p>Pusher block for 9.5mm</p>	 <p>Pusher block for 6mm and 12.5mm</p>	

Operation

Model: DB343/DB345	Model: DB344
<ul style="list-style-type: none"> Place the unit on a sturdy work surface. Core, slice, or cut the produce to prepare it for cutting. Lift the handle and place the produce on the blade. Remove hands and fingers from the cutting area. In one swift, fluid motion, press the pusher block down to force the produce through the blades. Lift the handle and repeat as needed. <p>Note: Do not attempt to chop any produce bigger than the opening in the blade holder.</p>	<ul style="list-style-type: none"> Place the unit on a sturdy work surface. Place a potato on the shield between the pusher block and the blade. Remove hands and fingers from the cutting area. Swiftly push the handle toward the blade to slice the potato into chips. Pull back the handle and repeat as needed. <p>Note: Do not attempt to cut potatoes bigger than the opening in the blade holder.</p>

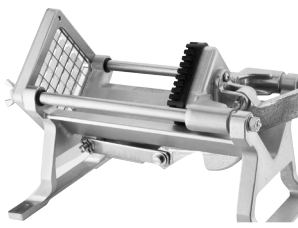
Changing the blade and pusher block

Model: DB343	Model: DB344	Model: DB345
<p>The product comes fully assembled with the 6 section blade and pusher block.</p> <p>Order other sizes of blade and pusher block as needed.</p> <p>To change the blade and pusher block:</p>	<p>The product comes fully assembled with the 9.5mm blade and pusher block.</p> <p>Order other sizes of blade and pusher block as needed.</p> <p>To change the blade and pusher block:</p>	
<ol style="list-style-type: none"> Lift the pusher block from the guide rods. Remove the screws from the bottom of the frame to release the blade assembly. Insert the desired blade assembly into the frame and fix with the screws. Unscrew the handle from the pusher block. Screw the handle into the desired pusher block. Slide the pusher block assembly down the guide rods. 	<ol style="list-style-type: none"> Remove the wing nuts from the blade holder to release the blade. Install the desired blade assembly and fix with the wing nuts. Remove the thumbscrews from the pusher block holder to release the pusher block. Attach the desired pusher block to the holder and fix with the thumbscrews. 	<ol style="list-style-type: none"> Lift the pusher block from the guide rods. Remove the 2 black bumpers from the guide rods. Then remove the blade assembly. Slide the desired blade assembly down the guide rods. Then install the bumpers. Remove the thumbscrews from the pusher block holder to release the pusher block. Attach the desired pusher block to the holder and fix with the thumbscrews. Slide the pusher block assembly down the guide rods. 

Cleaning, Care & Maintenance

- Disassemble the product as instructed (See Section "Changing the blade and pusher block").
- Clean the blade and pusher block thoroughly.
- Simply reverse the disassembly instructions to reassemble the product.
- When needed, lubricate the guide rods with mineral oil, food grade grease or paraffin. Do not use cooking oil.

All rights reserved. No part of these instructions may be produced or transmitted in any form or by any means, electronic, mechanical, photocopying, recording or otherwise, without the prior written permission of VOGUE.

Every effort is made to ensure all details are correct at the time of going to press, however, VOGUE reserve the right to change specifications without notice.

Veiligheidstips

- Voor de beste prestaties en langste levensduur van uw product, lees deze instructies en leef ze na.
- Reinig het toestel grondig vóór en na elk gebruik.
- Minimaliseer het gebruik van alkalische reinigingsmiddelen omdat deze putjes kunnen veroorzaken op de afwerking van het apparaat en deze dof kunnen maken.
- **Opgelet! De messen zijn ZEER SCHERP! Wees voorzichtig tijdens het bedienen en gebruiken van het apparaat. Houd uw handen steeds uit de buurt van de messen.**





















Productbeschrijving

DB343 - Fruit-/groentesnijder
DB345 - Groentehakker met mes van 9,5 mm

DB344 - Frietsnijder

Onderdelenlijst



Inhoud van verpakking	Optionele onderdelen (niet inbegrepen)		
 <p>Model: DB343</p>	 <p>Mes voor 6 gelijke stukken</p>	 <p>Mes voor 8 gelijke stukken</p>	 <p>Mes voor 10 gelijke stukken</p>
	 <p>Duwblok voor 6 gelijke stukken</p>	 <p>Duwblok voor 8 gelijke stukken</p>	 <p>Duwblok voor 10 gelijke stukken</p>
 <p>Model: DB344</p>	 <p>9,5 mm mes</p>	 <p>6 mm mes</p>	 <p>12,5 mm mes</p>
	 <p>Duwblok voor 9,5 mm</p>	 <p>Duwblok voor 6 mm en 12,5 mm</p>	

Inhoud van verpakking		Optionele onderdelen (niet inbegrepen)	
 <p>Model: DB345</p>	 <p>9,5 mm mes</p>	 <p>6 mm mes</p>	 <p>12,5 mm mes</p>
	 <p>Duwblok voor 9,5 mm</p>	 <p>Duwblok voor 6 mm en 12,5 mm</p>	

Bediening

Model: DB343/DB345	Model: DB344
<ul style="list-style-type: none"> • Plaats het toestel op een stevig werkoppervlak. • Boor het fruit of de groente uit en snij in plakjes of stukjes voordat u het apparaat gebruikt. • Til de hendel omhoog en plaats het fruit of de groente op het mes. • Verwijder handen en vingers uit het snijgebied. • Duw in één vlotte en vloeiende beweging het duwblok omlaag om het fruit of de groente door het mes te duwen. • Til de hendel omhoog en herhaal indien nodig. <p>Opmerking: Hak geen fruit of groente die groter is dan de opening in de meshouder.</p>	<ul style="list-style-type: none"> • Plaats het toestel op een stevig werkoppervlak. • Plaats een aardappel op het scherm tussen het duwblok en het mes. • Verwijder handen en vingers uit het snijgebied. • Duw de hendel snel richting het mes om de aardappel in friet te snijden. • Trek de hendel terug en herhaal, indien nodig. <p>Opmerking: Snij geen aardappelen die groter zijn dan de opening in de meshouder.</p>

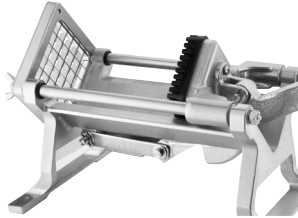
Het mes en het duwblok vervangen

Model: DB343	Model: DB344	Model: DB345
<p>Het product wordt volledig gemonteerd geleverd met het mes en het duwblok voor 6 gelijke stukken.</p> <p>Indien gewenst, bestel andere groottes van messen en duwblokken.</p> <p>Om het mes en het duwblok te vervangen:</p>	<p>Het product wordt volledig gemonteerd geleverd met het 9,5 mm mes en duwblok.</p> <p>Indien gewenst, bestel andere groottes van messen en duwblokken.</p> <p>Om het mes en het duwblok te vervangen:</p>	
<ol style="list-style-type: none"> 1. Til het duwblok uit de geleidestangen. 2. Verwijder de schroeven aan de onderkant van het frame om het mes los te maken. 3. Breng het gewenste mes aan in het frame en zet vast met de schroeven. 4. Schroef de hendel los van het duwblok. 5. Schroef de hendel in het gewenste duwblok. 6. Schuif het duwblok op de geleidestangen omlaag. 	<ol style="list-style-type: none"> 1. Verwijder de vleugelmoeren van de meshouder om het mes los te maken. 2. Installeer het gewenste mes en zet vast met de vleugelmoeren. 3. Verwijder de duimschroeven van de duwblokhouder om het duwblok los te maken. 4. Bevestig het gewenste duwblok aan de houder en zet vast met de duimschroeven. 	<ol style="list-style-type: none"> 1. Til het duwblok uit de geleidestangen. 2. Verwijder de 2 zwarte bumpers van de geleidestangen. Verwijder dan het mes. 3. Schuif het gewenste mes op de geleidestangen. Installeer dan de bumpers. 4. Verwijder de duimschroeven van de duwblokhouder om het duwblok los te maken. 5. Bevestig het gewenste duwblok aan de houder en zet vast met de duimschroeven. 6. Schuif het duwblok op de geleidestangen omlaag. 

Reiniging, zorg & onderhoud

- Haal het product uit elkaar zoals beschreven (zie de sectie "Het mes en het duwblok vervangen").
- Reinig het mes en het duwblok grondig.
- Voer de demontagestappen omgekeerd uit om het product opnieuw in elkaar te zetten.
- Indien nodig, smeer de geleidestangen met mineraalolie, een voedselveilig smeermiddel of paraffine. Gebruik geen bakolie.

Alle rechten voorbehouden. Het is verboden om deze handleiding, hetzij volledig of gedeeltelijk, elektronisch of mechanisch te reproduceren, kopiëren, op opslagmedia op te slaan of op enigerlei wijze over te dragen, zonder voorafgaande goedkeuring van VOGUE.

Wij hebben er alles aan gedaan om er zeker van te zijn dat op publicatiedatum van de handleiding alle details correct zijn, desondanks, behoudt VOGUE het recht voor om specificaties zonder aankondiging te wijzigen.

Consignes de sécurité

- Pour obtenir des performances optimales avec votre produit et améliorer sa durée d'utilisation, veuillez lire et respecter l'intégralité des présentes consignes.
- Nettoyez entièrement le produit avant et après chaque utilisation.
- Réduisez au minimum l'utilisation de produits de nettoyage alcalins. Ceux-ci risquent de provoquer des piqûres de corrosion et de ternir le fini.
- **Rappel : les lames sont TRÈS COUPANTES ! Faites attention lorsque vous manipulez et utilisez la machine. Toujours maintenir les mains à l'écart des lames.**















Description du produit







DB343 - Trancheuse fruits/légumes

DB344 - Trancheuse de croustilles

DB345 - Trancheuse en dés munie d'une lame de 9,5 mm

Liste des pièces



Contenu de l'emballage		Pièces en option (non fournies)		
 <p>Modèle : DB343</p>	 <p>Ensemble de lames 6 sections</p>	 <p>Ensemble de lames 8 sections</p>	 <p>Ensemble de lames 10 sections</p>	
	 <p>Bloc poussoir 6 sections</p>	 <p>Bloc poussoir 8 sections</p>	 <p>Bloc poussoir 10 sections</p>	
 <p>Modèle : DB344</p>	 <p>Ensemble de lames 9,5 mm</p>	 <p>Ensemble de lames 6 mm</p>	 <p>Ensemble de lames 12,5 mm</p>	
	 <p>Bloc poussoir pour 9,5 mm</p>	 <p>Bloc poussoir pour 6 mm et 12,5 mm</p>		

Contenu de l'emballage		Pièces en option (non fournies)	
 <p>Modèle : DB345</p>	 <p>Ensemble de lames 9,5 mm</p>	 <p>Ensemble de lames 6 mm</p>	 <p>Ensemble de lames 12,5 mm</p>
	 <p>Bloc poussoir pour 9,5 mm</p>	 <p>Bloc poussoir pour 6 mm et 12,5 mm</p>	

Fonctionnement

Modèle : DB343/DB345	Modèle : DB344
<ul style="list-style-type: none"> Placez l'appareil sur une surface de travail solide. Dénoyautez, coupez en tranches ou découpez les produits pour les apprêter pour le tranchage. Soulevez la poignée, puis placez les produits sur la lame. Retirez mains et doigts de la zone de coupe. D'un mouvement fluide et rapide, abaissez le bloc poussoir pour faire passer les produits à travers les lames. Relevez la lame, puis recommencez l'opération autant de fois que nécessaire. <p>Remarque : N'essayez pas de trancher un aliment plus large que l'ouverture du support de lame.</p>	<ul style="list-style-type: none"> Placez l'appareil sur une surface de travail solide. Placez une pomme de terre sur la protection située entre le bloc poussoir et la lame. Retirez mains et doigts de la zone de coupe. Poussez d'un geste rapide la poignée vers la lame pour trancher la pomme de terre en croustilles. Tirez la poignée vers l'arrière, puis recommencez l'opération autant de fois que nécessaire. <p>Remarque : Ne pas essayer de trancher des pommes de terre de taille supérieure à l'ouverture du support de lame.</p>

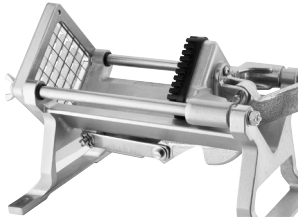
Remplacement de la lame et du bloc poussoir

Modèle : DB343	Modèle : DB344	Modèle : DB345
<p>Le produit est livré entièrement monté avec la lame 6 sections et le bloc poussoir.</p> <p>Commandez toutes autres tailles de lames et de blocs poussoirs au besoin.</p> <p>Pour remplacer la lame et le bloc poussoir :</p>	<p>Le produit est livré entièrement monté avec la lame 9,5 mm et le bloc poussoir.</p> <p>Commandez toutes autres tailles de lames et de blocs poussoirs au besoin.</p> <p>Pour remplacer la lame et le bloc poussoir :</p>	<p>Le produit est livré entièrement monté avec la lame 9,5 mm et le bloc poussoir.</p> <p>Commandez toutes autres tailles de lames et de blocs poussoirs au besoin.</p> <p>Pour remplacer la lame et le bloc poussoir :</p>
<ol style="list-style-type: none"> 1. Retirez le bloc poussoir des tiges de guidage. 2. Retirez les vis situées dans la partie inférieure du cadre pour libérer l'ensemble de lames. 3. Insérez l'ensemble de lames de votre choix dans le cadre, puis fixez-le à l'aide des vis. 4. Dévissez la poignée du bloc poussoir. 5. Revissez la poignée sur le bloc poussoir de votre choix. 6. Faites coulisser l'ensemble de blocs poussoirs le long des tiges de guidage. 	<ol style="list-style-type: none"> 1. Retirez les écrous papillon du support de lame pour libérer la lame. 2. Installez l'ensemble de lames de votre choix, puis fixez-le à l'aide des écrous papillon. 3. Retirez les vis papillon du support du bloc poussoir pour libérer le bloc. 4. Placez le bloc poussoir de votre choix sur le support, puis fixez-le à l'aide des vis papillon. 	<ol style="list-style-type: none"> 1. Retirez le bloc poussoir des tiges de guidage. 2. Enlevez les 2 tampons noirs des tiges, puis enlevez l'ensemble de lames. 3. Faites coulisser l'ensemble de lames le long des tiges de guidage, puis remettez les tampons. 4. Retirez les vis papillon du support du bloc poussoir pour libérer le bloc poussoir. 5. Placez le bloc poussoir de votre choix sur le support, puis fixez-le à l'aide des vis papillon. 6. Faites coulisser l'ensemble de blocs poussoirs le long des tiges de guidage. 

Nettoyage, entretien et maintenance

- Démontez le produit conformément aux instructions (voir la Section « Remplacement de la lame et du bloc poussoir »).
- Nettoyez entièrement la lame et le bloc poussoir.
- Remontez le produit en exécutant en sens inverse les instructions de démontage.
- Au besoin, lubrifiez les tiges de guidage à l'aide d'une huile minérale, de la graisse de qualité alimentaire ou de la paraffine. Ne pas utiliser de l'huile de cuisine.

Tous droits réservés. La production ou transmission, partielles ou intégrales, sous quelque forme que ce soit ou par n'importe quel moyen, tant électronique que mécanique, sous forme de photocopie, d'enregistrement ou autre de ce mode d'emploi sont interdites sans l'autorisation préalablement accordée par VOGUE.

Nous nous efforçons, par tous les moyens dont nous disposons, de faire en sorte que les détails contenus dans le présent mode d'emploi soient corrects en date d'impression. Toutefois, VOGUE se réserve le droit de changer les spécifications de ses produits sans préavis.

Sicherheitshinweise

- Um die beste Leistung und eine lange Lebensdauer Ihres Produktes zu gewährleisten, lesen und befolgen Sie diese Anleitung.
- Reinigen Sie das Produkt vor und nach jedem Gebrauch gründlich.
- Minimieren Sie den Einsatz von alkalischen Reinigungsmitteln, da diese zu Lochfraß und zur Mattierung der Oberfläche führen können.
- **Denken Sie daran, dass die Klingen SEHR SCHARF sind! Seien Sie vorsichtig bei der Handhabung und Bedienung des Gerätes. Halten Sie Ihre Hände immer von den Klingen fern.**

















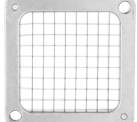
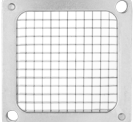
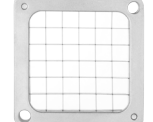

Produktbeschreibung

DB343 - Obst-/Gemüse-Spaltenschneider
DB345 - Gemüsewürfler mit 9,5 mm Klinge

DB344 - Pommesschneider

Teileliste



Lieferumfang		Optionales Zubehör (nicht im Lieferumfang enthalten)		
 <p>Modell: DB343</p>	 <p>Klingensatz für 6 Spalten</p>	 <p>Klingensatz für 8 Spalten</p>	 <p>Klingensatz für 10 Spalten</p>	
	 <p>Schieblock für 6 Spalten</p>	 <p>Schieblock für 8 Spalten</p>	 <p>Schieblock für 10 Spalten</p>	
 <p>Modell: DB344</p>	 <p>9,5 mm Klingensatz</p>	 <p>6 mm Klingensatz</p>	 <p>12,5 mm Klingensatz</p>	
	 <p>Schieblock für 9,5 mm</p>	 <p>Schieblock für 6 mm und 12,5 mm</p>		

Lieferumfang		Optionales Zubehör (nicht im Lieferumfang enthalten)	
 <p>Modell: DB345</p>	 <p>9,5 mm Klingensatz</p>	 <p>6 mm Klingensatz</p>	 <p>12,5 mm Klingensatz</p>
	 <p>Schiebeblock für 9,5 mm</p>	 <p>Schiebeblock für 6 mm und 12,5 mm</p>	

Betrieb

Modell: DB343/DB345	Modell: DB344
<ul style="list-style-type: none"> • Stellen Sie das Gerät auf eine stabile Arbeitsfläche. • Entkernen, teilen oder zerkleinern Sie das Obst/Gemüse, um es zum Schneiden vorzubereiten. • Heben Sie den Griff an und legen Sie das Obst/Gemüse auf den Klinge. • Halten Sie Hände und Finger vom Schneidbereich fern. • Drücken Sie den Schiebeblock in einer zügigen, fließenden Bewegung nach unten, um das Obst/Gemüse durch die Klinsen zu drücken. • Heben Sie den Griff an und wiederholen Sie den Vorgang nach Bedarf. <p>Hinweis: Versuchen Sie nicht, Obst-/Gemüsestücke zu zerkleinern, die größer sind als die Öffnung im Klingenthaler.</p>	<ul style="list-style-type: none"> • Stellen Sie das Gerät auf eine stabile Arbeitsfläche. • Legen Sie eine Kartoffel auf die Blende zwischen Schiebeblock und Klinge. • Halten Sie Hände und Finger vom Schneidbereich fern. • Drücken Sie den Griff zügig in Richtung Klinge, um die Kartoffel zu Pommes zu schneiden. • Ziehen Sie den Griff nach oben und wiederholen Sie den Vorgang nach Bedarf. <p>Hinweis: Versuchen Sie nicht, Kartoffeln zu schneiden, die größer sind als die Öffnung im Klingenthaler.</p>

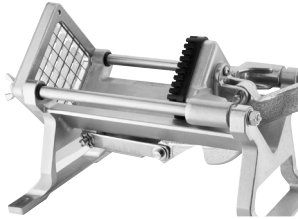
Klingensatz und Schiebblock wechseln

Modell: DB343	Modell: DB344	Modell: DB345
<p>Das Produkt wird komplett montiert mit einem Klingensatz und einem Schiebblock für 6 Spalten geliefert. Bestellen Sie bei Bedarf Klingensätze und Schiebblöcke in anderen Größen. Zum Wechseln der Klinge und des Schiebblocks:</p>	<p>Das Produkt wird komplett montiert mit einem 9,5 mm Klingensatz und Schiebblock geliefert. Bestellen Sie bei Bedarf Klingensätze und Schiebblöcke in anderen Größen. Zum Wechseln der Klinge und des Schiebblocks:</p>	
<ol style="list-style-type: none"> 1. Ziehen Sie den Schiebblock von den Führungsstangen. 2. Entfernen Sie die Schrauben von der Unterseite des Rahmens, um den Klingensatz zu lösen. 3. Setzen Sie den gewünschten Klingensatz in den Rahmen ein und befestigen Sie ihn mit den Schrauben. 4. Schrauben Sie den Griff vom Schiebblock ab. 5. Schrauben Sie den Griff an den gewünschten Schiebblock. 6. Schieben Sie den Schiebblock über die Führungsstangen nach unten. 	<ol style="list-style-type: none"> 1. Entfernen Sie die Flügelmuttern vom Klingenthaler, um die Klinge zu lösen. 2. Setzen Sie den gewünschten Klingensatz ein und befestigen Sie ihn mit den Flügelmuttern. 3. Entfernen Sie die Flügelschrauben vom Halter des Schiebblocks, um den Schiebblock zu lösen. 4. Setzen Sie den gewünschten Schiebblock auf den Halter und befestigen Sie ihn mit den Flügelschrauben. 	<ol style="list-style-type: none"> 1. Ziehen Sie den Schiebblock von den Führungsstangen. 2. Entfernen Sie die beiden schwarzen Stoßfänger von den Führungsstangen. Entfernen Sie danach den Klingensatz. 3. Schieben Sie den gewünschten Klingensatz in die Führungsstangen. Befestigen Sie danach die Stoßfänger. 4. Entfernen Sie die Flügelschrauben vom Halter des Schiebblocks, um den Schiebblock zu lösen. 5. Setzen Sie den gewünschten Schiebblock auf den Halter und befestigen Sie ihn mit den Flügelschrauben. 6. Schieben Sie den Schiebblock über die Führungsstangen nach unten.
		

Reinigung, Pflege und Wartung

- Zerlegen Sie das Produkt den Anweisungen entsprechend (siehe Abschnitt „Klingensatz und Schiebblock wechseln“).
- Reinigen Sie den Klingensatz und den Schiebblock gründlich.
- Um das Produkt wieder zusammenzubauen, führen Sie die Anweisungen zur Demontage in umgekehrter Reihenfolge durch.
- Schmieren Sie die Führungsstangen bei Bedarf mit Mineralöl, lebensmitteleuglichem Fett oder Paraffin. Verwenden Sie kein Speiseöl.

Alle Rechte vorbehalten. Diese Anleitung darf ohne vorherige schriftliche Genehmigung von BOLERO weder ganz noch teilweise in irgendeiner Form oder auf irgendeinem Wege - einschließlich elektronischer, mechanischer Verfahren, durch Fotokopieren, Aufnahme oder andere Verfahren - vervielfältigt oder übertragen werden.

Es werden alle Anstrengungen unternommen um sicherzustellen, dass alle Angaben bei der Drucklegung korrekt sind. BOLERO behält sich jedoch das Recht vor, Spezifikationen ohne Vorankündigung zu ändern.

Suggerimenti per la sicurezza

- Per ottenere le prestazioni migliori e allungare la durata del prodotto, si prega di leggere e seguire le istruzioni indicate.
- Pulire accuratamente il prodotto prima e dopo ogni l'uso.
- Minimizzare l'uso dei pulitori alcalini, in quanto questi possono causare la corrosione e l'opacizzazione delle finiture.
- **Si prega di ricordare che le lame sono MOLTO AFFILATE! Porre molta attenzione quando si maneggia e usa la macchina in funzionamento. Tenere sempre le mani lontano dalle lame.**















Descrizione del prodotto





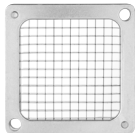

DB343 - Taglierina per frutta/verdura

DB345 - Cubettatrice per verdura con lama da 9,5 mm

DB344 - Taglierina per patatine fritte

Elenco Componenti



Contenuto della confezione		Componenti opzionali (non forniti)		
 <p>Modello: DB343</p>	 <p>Gruppo lame a 6 sezioni</p>	 <p>Gruppo lame a 8 sezioni</p>	 <p>Gruppo lame a 10 sezioni</p>	
	 <p>Blocco spinta a 6 sezioni</p>	 <p>Blocco spinta a 8 sezioni</p>	 <p>Blocco spinta a 10 sezioni</p>	
 <p>Modello: DB344</p>	 <p>Gruppo lame da 9,5 mm</p>	 <p>Gruppo lame da 6 mm</p>	 <p>Gruppo lame da 12,5 mm</p>	
	 <p>Blocco spinta per lame da 9,5 mm</p>	 <p>Blocco spinta da 6 mm e 12,5 mm</p>		

Contenuto della confezione		Componenti opzionali (non forniti)	
 <p>Modello: DB345</p>	 <p>Gruppo lame da 9,5 mm</p>	 <p>Gruppo lame da 6 mm</p>	 <p>Gruppo lame da 12,5 mm</p>
	 <p>Blocco spinta per lame da 9,5 mm</p>	 <p>Blocco spinta da 6mm e 12,5mm</p>	

Funzionamento

Modello: DB343/DB345	Modello: DB344
<ul style="list-style-type: none"> • Collocare l'unità su una solida superficie di lavoro. • Togliere il torsolo, affettare o tagliare il prodotto per prepararlo. • Sollevare il manico e collocare il prodotto sulla lama. • Allontanare le mani e le dita dall'area di taglio. • Con un movimento fluido e rapido, premere il blocco spinta e spingere il prodotto attraverso le lame. • Sollevare il manico e ripetere l'operazione se necessario. <p>Nota: non cercare di tagliare un prodotto di dimensioni maggiori dell'apertura del portalamo.</p>	<ul style="list-style-type: none"> • Collocare l'unità su una solida superficie di lavoro. • Disporre una patata sulla protezione fra il blocco spinta e la lama. • Allontanare le mani e le dita dalla superficie di taglio. • Spingere rapidamente il manico verso la lama per tagliare la patata in piccole fettine. • Tirare indietro il manico e ripetere l'operazione se necessario. <p>Nota: non cercare di tagliare le patate con dimensioni maggiori dell'apertura del portalamo.</p>

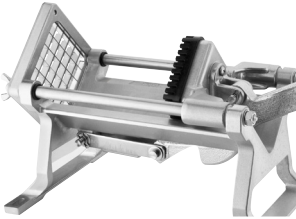
Cambio della lama e del blocco di spinta

Modello: DB343	Modello: DB344	Modello: DB345
<p>Il prodotto è consegnato completamente assemblato con un gruppo lame e un blocco spinta da 6 sezioni.</p> <p>Ordinare i gruppi lame e blocchi spinta di diverse dimensioni se necessario.</p> <p>Per cambiare il gruppo lame e il blocco spinta:</p>	<p>Il prodotto è consegnato completamente assemblato con la lama da 9,5 mm e il blocco di spinta.</p> <p>Ordinare i gruppi lame e blocchi spinta di diverse dimensioni se necessario.</p> <p>Per cambiare il gruppo lame e il blocco spinta:</p>	<p>Il prodotto è consegnato completamente assemblato con la lama da 9,5 mm e il blocco di spinta.</p> <p>Ordinare i gruppi lame e blocchi spinta di diverse dimensioni se necessario.</p> <p>Per cambiare il gruppo lame e il blocco spinta:</p>
<ol style="list-style-type: none"> 1. Sollevare il blocco spinta dagli assi guida. 2. Rimuovere le viti dalla base del telaio per rilasciare il gruppo lame. 3. Inserire il gruppo lame desiderato nel telaio e fissarlo con le viti. 4. Svitare il manico del blocco spinta. 5. Avvitare il manico nel blocco spinta desiderato. 6. Far scorrere il blocco spinta lungo gli assi guida. 	<ol style="list-style-type: none"> 1. Rimuovere i dadi a farfalla dal portalamo per rilasciare la lama. 2. Installare il gruppo lame desiderato e fissarlo con i dadi a farfalla. 3. Rimuovere le viti ad alette dal supporto del blocco spinta per rilasciare il blocco stesso. 4. Disporre il blocco spinta desiderato sul supporto e fissarlo con le viti ad alette. 	<ol style="list-style-type: none"> 1. Sollevare il blocco spinta dagli assi guida. 2. Rimuovere le 2 protezioni nere dagli assi guida. Successivamente, rimuovere il gruppo lame. 3. Far scivolare il gruppo lame desiderato lungo gli assi guida. Successivamente, installare le protezioni. 4. Rimuovere le viti ad alette dal supporto del blocco spinta per rilasciare il blocco spinta stesso. 5. Disporre il blocco spinta desiderato sul supporto e fissarlo con le viti ad alette. 6. Far scivolare il gruppo blocco spinta lungo gli assi guida. 

Pulizia e manutenzione

- Smontare il prodotto secondo le istruzioni (vedere la sezione Cambio della lama e del blocco spinta”).
- Pulire a fondo il gruppo lame e il blocco spinta.
- Per rimontare il prodotto è sufficiente seguire le istruzioni di smontaggio al contrario.
- Lubrificare gli assi guida con olio minerale, grasso alimentare o paraffina se necessario. Non usare olio alimentare.

Tutti i diritti riservati. È vietata la riproduzione o la trasmissione in alcuna forma, elettronica, meccanica, mediante fotocopiatura o altro sistema di riproduzione, di qualsiasi parte delle presenti istruzioni senza la previa autorizzazione scritta di VOGUE.
Le informazioni contenute sono corrette e accurate al momento della stampa, tuttavia VOGUE si riserva il diritto di modificare le specifiche senza preavviso.

Consejos de seguridad

- Para obtener el mejor rendimiento y vida útil del producto, lea y siga estas instrucciones.
- Limpie bien el aparato antes y después de cada uso.
- Minimice el uso de limpiadores alcalinos, ya que pueden causar picaduras y deslustrar el acabado.
- **Recuerde que las cuchillas están MUY AFILADAS. Tenga cuidado cuando esté manipulando u operando la máquina. Mantenga las manos alejadas de las cuchillas en todo momento.**















Descripción del producto







DB343 - Cortadora de fruta/verdura en cuña

DB344 - Cortadora de patatas fritas

DB345 - Cortadora de verdura en cubos con cuchilla de 9,5 mm

Lista de piezas



Contenido del paquete		Piezas opcionales (no incluidas)		
 <p>Modelo: DB343</p>	 <p>Cuchilla de 6 secciones</p>	 <p>Cuchilla de 8 secciones</p>	 <p>Cuchilla de 10 secciones</p>	
	 <p>Bloque empujador de 6 secciones</p>	 <p>Bloque empujador de 8 secciones</p>	 <p>Bloque empujador de 10 secciones</p>	
 <p>Modelo: DB344</p>	 <p>Cuchilla de 9,5 mm</p>	 <p>Cuchilla de 6 mm</p>	 <p>Cuchilla de 12,5 mm</p>	
	 <p>Bloque empujador para 9,5 mm</p>	 <p>Bloque empujador para 6 mm y 12,5 mm</p>		

Contenido del paquete		Piezas opcionales (no incluidas)	
 <p>Modelo: DB345</p>	 <p>Cuchilla de 9,5 mm</p>	 <p>Cuchilla de 6 mm</p>	 <p>Cuchilla de 12,5 mm</p>
	 <p>Bloque empujador para 9,5 mm</p>	 <p>Bloque empujador para 6 mm y 12,5 mm</p>	

Funcionamiento

Modelo: DB343/DB345	Modelo: DB344
<ul style="list-style-type: none"> • Coloque el producto sobre una superficie firme. • Deshuese, corte en rodajas o trocee los alimentos para prepararlos para el corte. • Levante el asa y, a continuación, coloque los alimentos sobre la cuchilla. • Mantenga las manos y los dedos alejados de la zona de corte. • Con un movimiento rápido y fluido, presione el bloque empujador hacia abajo para hacer que los alimentos pasen a través de la cuchilla. • Levante el asa y repita las veces que sea necesario. <p>Nota: no intente picar trozos más grandes que la abertura del soporte de la cuchilla.</p>	<ul style="list-style-type: none"> • Coloque el producto sobre una superficie firme. • Coloque una patata en el protector situado entre el bloque empujador y la cuchilla. • Mantenga las manos y los dedos alejados de la zona de corte. • Empuje el asa hacia la cuchilla con un movimiento rápido para cortar la patata en trozos. • Tire del asa para devolverlo a su posición inicial y repita las veces que sea necesario. <p>Nota: no intente cortar patatas más grandes que la abertura del soporte de la cuchilla.</p>

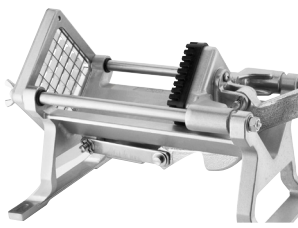
Cómo cambiar la cuchilla y el bloque empujador

Modelo: DB343	Modelo: DB344	Modelo: DB345
<p>El producto viene totalmente ensamblado con la cuchilla y el bloque empujador de 6 secciones.</p> <p>Solicite otros tamaños de cuchilla y bloque empujador de acuerdo con sus necesidades.</p> <p>Para cambiar la cuchilla y el bloque empujador:</p>	<p>El producto viene totalmente ensamblado con la cuchilla y el bloque empujador de 9,5 mm.</p> <p>Solicite otros tamaños de cuchilla y bloque empujador de acuerdo con sus necesidades.</p> <p>Para cambiar la cuchilla y el bloque empujador:</p>	<p>El producto viene totalmente ensamblado con la cuchilla y el bloque empujador de 9,5 mm.</p> <p>Solicite otros tamaños de cuchilla y bloque empujador de acuerdo con sus necesidades.</p> <p>Para cambiar la cuchilla y el bloque empujador:</p>
<ol style="list-style-type: none"> 1. Retire el bloque empujador de las barras guía. 2. Retire los tornillos de la parte inferior del bastidor para liberar la ensamblaje de cuchilla. 3. Inserte la ensamblaje de cuchilla que desee en el bastidor y, a continuación, fije con los tornillos. 4. Desenrosque el asa del bloque empujador. 5. Enrosque el asa en el bloque empujador que desee. 6. Coloque el ensamblaje de bloque empujador en las barras guía. 	<ol style="list-style-type: none"> 1. Retire las tuercas de mariposa del soporte de la cuchilla para liberarla. 2. Instale la ensamblaje de cuchilla que desee y, a continuación, fije con las tuercas de mariposa. 3. Retire los tornillos de orejeta del soporte del bloque empujador para liberar el bloque empujador. 4. Coloque el bloque empujador que desee en el soporte y, a continuación, fije con los tornillos de orejeta. 	<ol style="list-style-type: none"> 1. Retire el bloque empujador de las barras guía. 2. Retire los 2 topes negros de las barras guía y, a continuación, retire la ensamblaje de cuchilla. 3. Coloque la ensamblaje de cuchilla que desee en las barras guía y, a continuación, vuelva a colocar los topes. 4. Retire los tornillos de orejeta del soporte del bloque empujador para liberar el bloque empujador. 5. Coloque el bloque empujador que desee en el soporte y, a continuación, fije con los tornillos de orejeta. 6. Coloque el ensamblaje de bloque empujador en las barras guía. 

Limpieza, cuidado y mantenimiento

- Desmonte el aparato de acuerdo con las instrucciones (consulte la sección "Cómo cambiar la cuchilla y el bloque empujador").
- Limpie bien la cuchilla y el bloque empujador.
- Siga las instrucciones de desmontaje en sentido inverso para volver a ensamblar el producto.
- Cuando sea necesario, lubrique las barras guía con aceite mineral, grasa de calidad apta para aplicaciones alimentaria o parafina. No utilice aceite de cocina.

Reservados todos los derechos. Puede estar prohibida la reproducción o transmisión en cualquier forma o por cualquier medio electrónico, mecánico, de fotocopiado, registro o de otro tipo, de cualquier parte de estas instrucciones sin la autorización previa y por escrito de VOGUE. Se ha hecho todo lo posible para garantizar que todos los datos son correctos en el momento de su publicación; sin embargo, VOGUE se reserva el derecho a modificar las especificaciones sin que medie notificación previa.

Conselhos de segurança

- Para obter o melhor desempenho e vida útil do seu produto, leia e siga estas instruções.
- Limpe o produto completamente antes e depois de cada uso.
- Minimize o uso de produtos de limpeza alcalinos, pois eles podem causar corrosão e entorpecimento do acabamento.
- **Lembre-se que as lâminas são muito afiadas! Tenha cuidado ao manusear e operar a máquina. Mantenha sempre as mãos afastadas das lâminas.**













Descrição do Produto





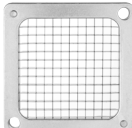
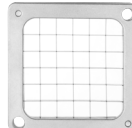

DB343 - Cortador em cunha de frutas/vegetais

DB344 - Cortador de batatas às rodela

DB345 - Cortador de vegetais com uma lâmina de 9,5 mm

Conteúdo da embalagem



Conteúdo da embalagem		Peças opcionais (não fornecidas)		
 <p>Modelo: DB343</p>	 <p>Conjunto de lâminas de 6 seções</p>	 <p>Conjunto de lâminas de 8 seções</p>	 <p>Conjunto de lâminas de 10 seções</p>	
	 <p>Bloco empurrador de 6 seções</p>	 <p>Bloco empurrador de 8 seções</p>	 <p>Bloco empurrador de 10 seções</p>	
 <p>Modelo: DB344</p>	 <p>Conjunto de lâminas de 9,5 mm</p>	 <p>Conjunto de lâminas de 6 mm</p>	 <p>Conjunto de lâminas de 12,5 mm</p>	
	 <p>Bloco empurrador para 9,5 mm</p>	 <p>Bloco empurrador de 6 mm e 12,5 mm</p>		

Conteúdo da embalagem		Peças opcionais (não fornecidas)	
 <p>Modelo: DB345</p>	 <p>Conjunto de lâminas de 9,5 mm</p>	 <p>Conjunto de lâminas de 6 mm</p>	 <p>Conjunto de lâminas de 12,5 mm</p>
	 <p>Bloco empurrador para 9,5 mm</p>	 <p>Bloco empurrador de 6 mm e 12,5 mm</p>	

Funcionamento

Modelo: DB343/DB345	Modelo: DB344
<ul style="list-style-type: none"> • Coloque a unidade sobre uma superfície de trabalho resistente. • Descaroce, fatie ou corte o produto para prepará-lo para o corte. • Levante a pega e coloque o produto na lâmina. • Retire as mãos e os dedos da área de corte. • Com um movimento rápido e fluido, pressione o bloco empurrador para forçar o produto através das lâminas. • Levante a pega e repita conforme necessário. <p>Nota: Não tente cortar nenhum produto maior que a abertura no porta-lâmina.</p>	<ul style="list-style-type: none"> • Coloque a unidade sobre uma superfície de trabalho resistente. • Coloque uma batata na proteção entre o bloco empurrador e a lâmina. • Retire as mãos e os dedos da área de corte. • Rapidamente, empurre a pega em direção à lâmina para cortar a batata às rodela. • Puxe o manípulo para trás e repita conforme necessário. <p>Nota: Não tente cortar batatas maiores que a abertura no porta-lâmina.</p>

Mudar a lâmina e o bloco empurrador

Modelo: DB343	Modelo: DB344	Modelo: DB345
<p>O produto vem completamente montado com a lâmina de 6 secções e o bloco empurrador.</p> <p>Peça outros tamanhos de lâminas e de blocos empurradores conforme necessário.</p> <p>Para mudar a lâmina e o bloco empurrador:</p>	<p>O produto vem completamente montado com a lâmina de 9,5 mm e o bloco empurrador.</p> <p>Peça outros tamanhos de lâminas e de blocos empurradores conforme necessário.</p> <p>Para mudar a lâmina e o bloco empurrador:</p>	<p>O produto vem completamente montado com a lâmina de 9,5 mm e o bloco empurrador.</p> <p>Peça outros tamanhos de lâminas e de blocos empurradores conforme necessário.</p> <p>Para mudar a lâmina e o bloco empurrador:</p>
<ol style="list-style-type: none"> 1. Levante o bloco empurrador das barras guia. 2. Remova os parafusos da parte inferior da estrutura para soltar o conjunto da lâmina. 3. Insira o conjunto de lâminas desejado no quadro e fixe-o com os parafusos. 4. Desaperte o manípulo do empurrador do bloco. 5. Aparafuse a pega no bloco empurrador desejado. 6. Deslize o conjunto do bloco empurrador pelas barras guia. 	<ol style="list-style-type: none"> 1. Remova as porcas do suporte da lâmina para soltar a lâmina. 2. Instale o conjunto de lâminas desejado e fixe-o com os parafusos de orelhas. 3. Remova os parafusos de aperto manual do suporte do bloco empurrador para soltar o bloco empurrador. 4. Coloque o bloco empurrador desejado no suporte e fixe-o com os parafusos. 	<ol style="list-style-type: none"> 1. Levante o bloco empurrador das barras guia. 2. Remova os 2 protetores pretos das barras guia e, em seguida, remova o conjunto da lâmina. 3. Deslize o conjunto da lâmina desejado pelas barras guia. Em seguida, instale os batentes. 4. Remova os parafusos de aperto manual do suporte do bloco empurrador para o soltar. 5. Coloque o bloco empurrador desejado no suporte e fixe-o com os parafusos. 6. Deslize o conjunto bloco empurrador pelas barras guia. 

Limpeza, cuidados & manutenção

- Desmonte o produto de acordo com as instruções (consulte a secção "Mudar a lâmina e o bloco empurrador").
- Limpe bem a lâmina e o bloco empurrador.
- Simplesmente inverta as instruções de desmontagem para voltar a montar o produto.
- Quando necessário, lubrifique as barras guia com óleo mineral, lubrificante de qualidade alimentar ou parafina. Não use óleo de cozinha.

Todos os direitos reservados. É proibida a reprodução electrónica ou mecânica, ou por qualquer outro meio copiar, guardar em meios digitais ou transmitir a terceiros estas instruções, seja parcialmente ou na sua totalidade, sem a autorização prévia de BOLERO. Nós nos esforçamos para que no dia de publicação deste manual todos os pormenores sejam correctos, no entanto, a BOLERO tem o direito de alterar as especificações sem aviso prévio.



UK	0845 146 2887	Fourth Way, Avonmouth, Bristol, BS11 8TB United Kingdom
Eire		42 North Point Business Park, New Mallow Road, Cork, Ireland
NL	040 – 2628080	
FR	01 60 34 28 80	
BE-NL	0800-29129	
BE-FR	0800-29229	
DE	0800 – 1860806	
IT	N/A	
ES	901-100 133	
PT	vendas@nisbets.pt	
AU	1300 225 960	15 Badgally Road, Campbelltown, 2560, NSW, Australia

VOGUE

DB343-DB344-DB345_ML_A5_v2_20200817