

Exploded diagram and spare parts list

For machines with - T316-04

[Click](#)





From 5091040-UK(9C19080001-9C19080342), 24958-EU(5CB19090001-5CB19090248) onwards

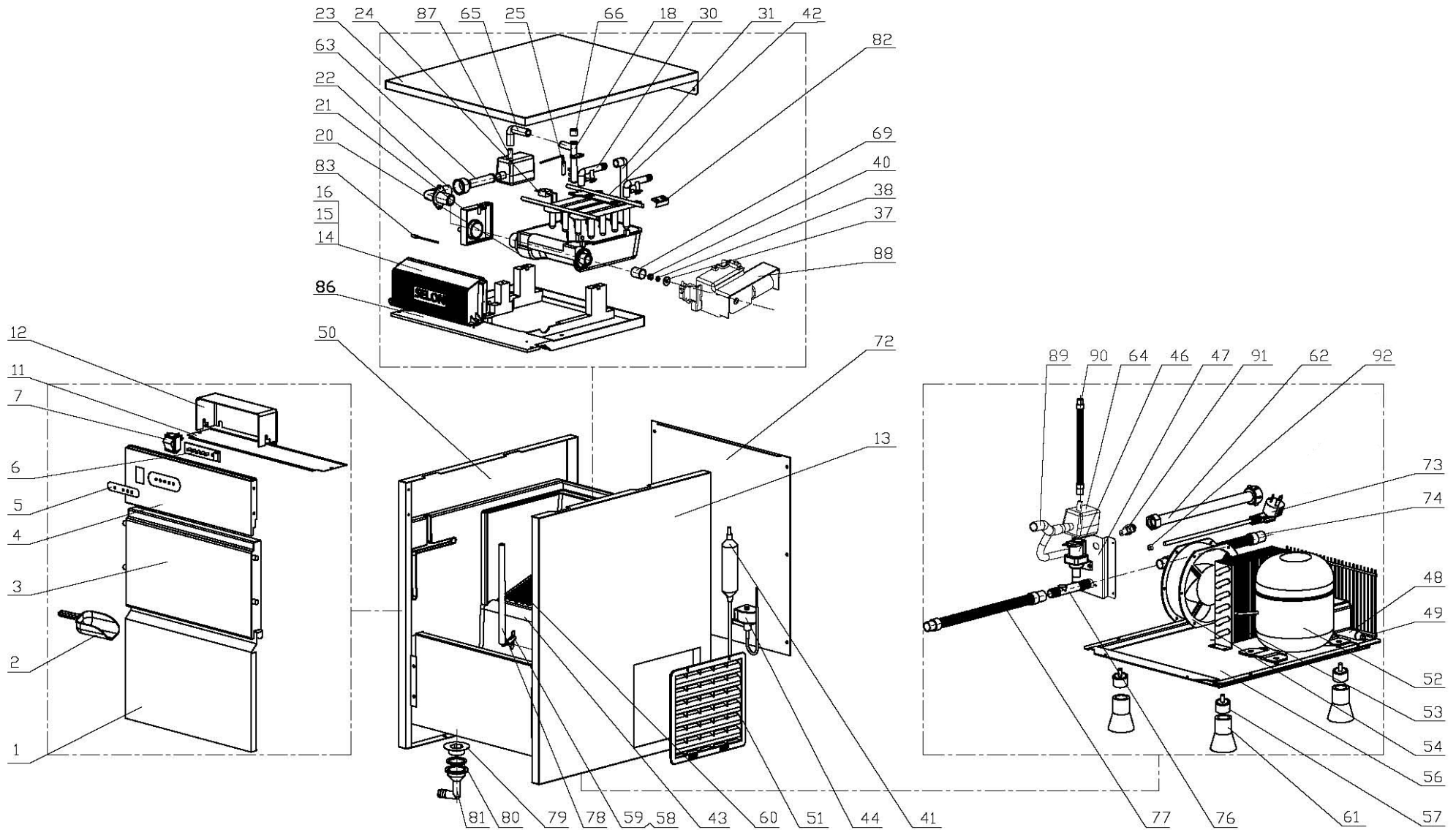

For machines with – T316

[Click](#)



Prior to 5091040-UK(9C19080001-9C19080342), 24958-EU(5CB19090001-5CB19090248)





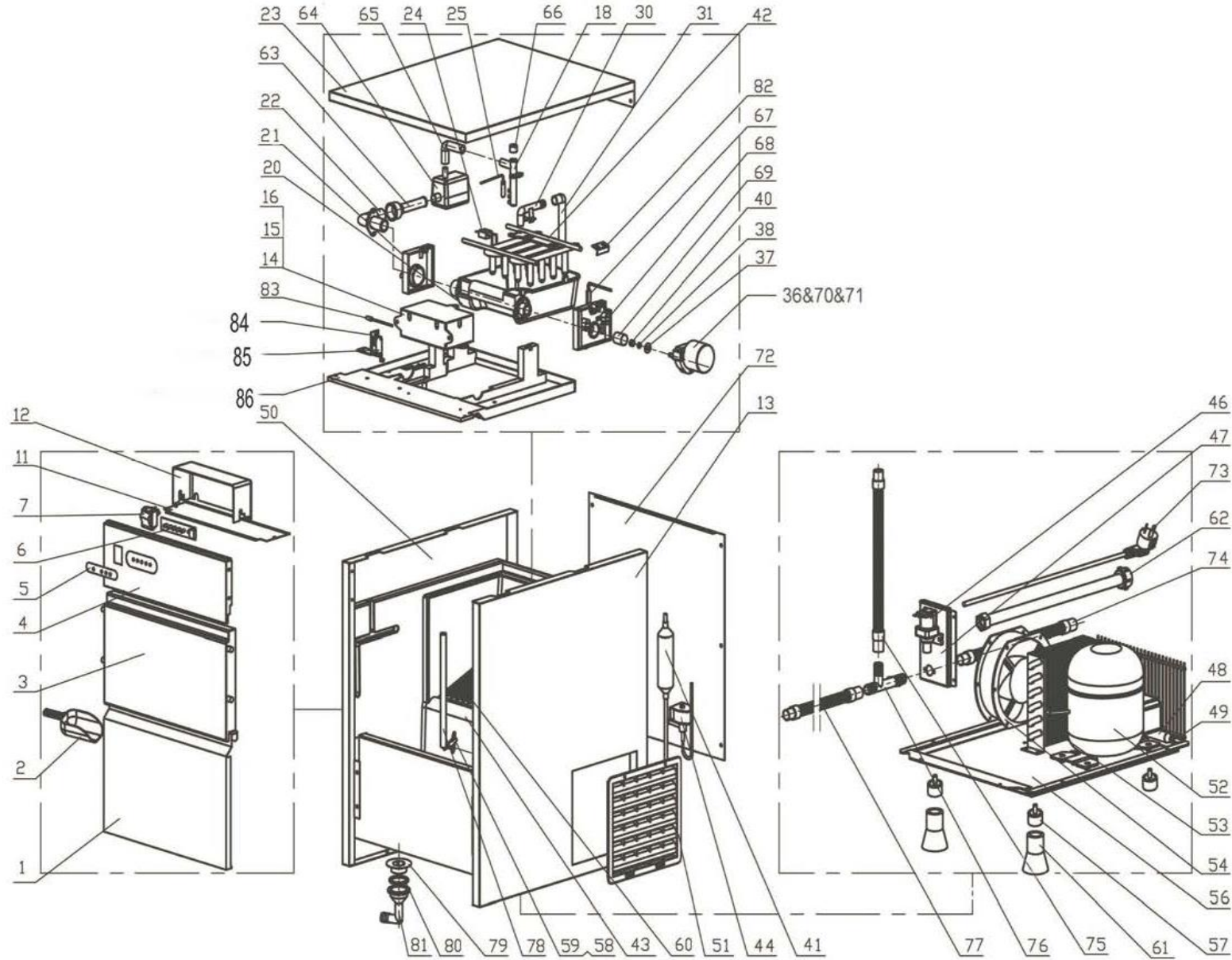

Machine	Explode	Code	Description
T316 - Polar Countertop Ice Machine 20kg Output	1	AA220	Bottom Panel
T316 - Polar Countertop Ice Machine 20kg Output	2	AA107	Ice Scoop
T316 - Polar Countertop Ice Machine 20kg Output	3	AA222	Door/Switch Panel
T316 - Polar Countertop Ice Machine 20kg Output	4	AA223	Upper Panel
T316 - Polar Countertop Ice Machine 20kg Output	5	AH074	ZBP Operation Panel Sticker
T316 - Polar Countertop Ice Machine 20kg Output	6	AH346	Indicator Panel with Auto-Clean Display
T316 - Polar Countertop Ice Machine 20kg Output	7	AA226	On-off Switch
T316 - Polar Countertop Ice Machine 20kg Output	11	AA230	Upper Edge Panel
T316 - Polar Countertop Ice Machine 20kg Output	12		Operation Panel Cover
T316 - Polar Countertop Ice Machine 20kg Output	13		Right Panel
T316 - Polar Countertop Ice Machine 20kg Output	14.15.16	AK372	DC Main Control Box Assembly
T316 - Polar Countertop Ice Machine 20kg Output	18	AA237	Water Shower
T316 - Polar Countertop Ice Machine 20kg Output	20	AA239	Water Box
T316 - Polar Countertop Ice Machine 20kg Output	21	AA240	Evaporator Fixer
T316 - Polar Countertop Ice Machine 20kg Output	22	AA241	Rinsing Connector
T316 - Polar Countertop Ice Machine 20kg Output	23		Top Panel
T316 - Polar Countertop Ice Machine 20kg Output	24	AA129	Water Level Sensor-old version
T316 - Polar Countertop Ice Machine 20kg Output	24	AL127	Water Level Sensor-From 5124070-UK
T316 - Polar Countertop Ice Machine 20kg Output	25	AA244	Water Temperature Sensor
T316 - Polar Countertop Ice Machine 20kg Output	30	AA249	Water Inlet Head
T316 - Polar Countertop Ice Machine 20kg Output	31	AA250	Water Filling Tube
T316 - Polar Countertop Ice Machine 20kg Output	37	AA256	Big Washer
T316 - Polar Countertop Ice Machine 20kg Output	38	AA257	Butterfly Shape Washer
T316 - Polar Countertop Ice Machine 20kg Output	40	AA115	Stopper
T316 - Polar Countertop Ice Machine 20kg Output	41	AA260	Diffused Device
T316 - Polar Countertop Ice Machine 20kg Output	42	AA261	Evaporator
T316 - Polar Countertop Ice Machine 20kg Output	43		Cabinet Liner
T316 - Polar Countertop Ice Machine 20kg Output	44	AA263	Magnet Valve
T316 - Polar Countertop Ice Machine 20kg Output	46	AA265	Water Inlet Valve
T316 - Polar Countertop Ice Machine 20kg Output	47		Water Valve Fixing Board (With Water Pump)
T316 - Polar Countertop Ice Machine 20kg Output	48	AA267	Filter Drier
T316 - Polar Countertop Ice Machine 20kg Output	49	AA268	Steel Grill
T316 - Polar Countertop Ice Machine 20kg Output	50		Left Panel
T316 - Polar Countertop Ice Machine 20kg Output	51		Grill
T316 - Polar Countertop Ice Machine 20kg Output	52	AG872	Compressor(R600a)
T316 - Polar Countertop Ice Machine 20kg Output	53	AA272	Condenser
T316 - Polar Countertop Ice Machine 20kg Output	54	AA273	Fan
T316 - Polar Countertop Ice Machine 20kg Output	56		Compressor Fixing Board
T316 - Polar Countertop Ice Machine 20kg Output	57	AA276	Feet
T316 - Polar Countertop Ice Machine 20kg Output	61	AB096	Rubber Foot
T316 - Polar Countertop Ice Machine 20kg Output	58	AA244	Ice Level Sensor
T316 - Polar Countertop Ice Machine 20kg Output	59	AA278	Ice Level Sensor Fixer
T316 - Polar Countertop Ice Machine 20kg Output	60	AA279	Ice Flopping Shelf
T316 - Polar Countertop Ice Machine 20kg Output	62	AE695	Water Inlet Pipe/WRAS Approved Hose
T316 - Polar Countertop Ice Machine 20kg Output	63	AM397	Water Recycling Tube for TP-600

T316 - Polar Countertop Ice Machine 20kg Output	64	AA560	Pump (Model:TP-450)
T316 - Polar Countertop Ice Machine 20kg Output	65	AM398	Pump Connector for TP-600
T316 - Polar Countertop Ice Machine 20kg Output	66	AE944	Water Shower Cover
T316 - Polar Countertop Ice Machine 20kg Output	69	AH060	Axis Cover
T316 - Polar Countertop Ice Machine 20kg Output	72	AL569	Back Panel
T316 - Polar Countertop Ice Machine 20kg Output	73	AN294	UK Power Cord
T316 - Polar Countertop Ice Machine 20kg Output	74	AE948	Drainage Tube/Water Inlet Tube
T316 - Polar Countertop Ice Machine 20kg Output	76	AL496	Icing Water Discharge Connector (Two Way)
T316 - Polar Countertop Ice Machine 20kg Output	77	AE950	Icing Water Discharge Tube
T316 - Polar Countertop Ice Machine 20kg Output	78		Wiring Tube
T316 - Polar Countertop Ice Machine 20kg Output	79	AL611	Drainage Cover
T316 - Polar Countertop Ice Machine 20kg Output	80	AE699	Seal Washer for Drainage Connector
T316 - Polar Countertop Ice Machine 20kg Output	81	AH061	Discharged Elbow Connector
T316 - Polar Countertop Ice Machine 20kg Output	82	AM294	Metal Bracket
T316 - Polar Countertop Ice Machine 20kg Output	83	AG101	Ambient Temp Sensor
T316 - Polar Countertop Ice Machine 20kg Output	86		Plastic Upper Fixing Board
T316 - Polar Countertop Ice Machine 20kg Output	87	AH023	TP-600 Water Pump
T316 - Polar Countertop Ice Machine 20kg Output	88	AG104	DC Tray Motor Subassembly
T316 - Polar Countertop Ice Machine 20kg Output	89	AL322	ZBY-26 Water Recycling T Tube
T316 - Polar Countertop Ice Machine 20kg Output	90	AL323	Recycle Tube
T316 - Polar Countertop Ice Machine 20kg Output	91	AG111	Water Outlet Valve Assembly
T316 - Polar Countertop Ice Machine 20kg Output	92		Power Cord Fixer
T316 - Polar Countertop Ice Machine 20kg Output	N/A	AN767	Electrics for Compressor QD91Y
T316 - Polar Countertop Ice Machine 20kg Output	N/A	AM026	Wiring L=300mm
T316 - Polar Countertop Ice Machine 20kg Output	N/A	AP638	Wire Connection for PCB to Water Level Probe



Machine	Explode	Code	Description
T316 - Polar Countertop Ice Machine 20kg Output	1	AA220	Bottom Panel
T316 - Polar Countertop Ice Machine 20kg Output	2	AA107	Ice Scoop
T316 - Polar Countertop Ice Machine 20kg Output	3	AA222	Door
T316 - Polar Countertop Ice Machine 20kg Output	4	AA223	Upper Panel
T316 - Polar Countertop Ice Machine 20kg Output	5	AA224	PVC Cover
T316 - Polar Countertop Ice Machine 20kg Output	6	AA102	Indicator Panel
T316 - Polar Countertop Ice Machine 20kg Output	7	AA226	On-off Switch
T316 - Polar Countertop Ice Machine 20kg Output	11	AA230	Upper Edge Panel
T316 - Polar Countertop Ice Machine 20kg Output	12		Operation Panel Cover
T316 - Polar Countertop Ice Machine 20kg Output	13		Right Panel
T316 - Polar Countertop Ice Machine 20kg Output	14	AA233	Control Box
T316 - Polar Countertop Ice Machine 20kg Output	16		Control Box Cover
T316 - Polar Countertop Ice Machine 20kg Output	15	AN166	Control Board(R134a)-old
T316 - Polar Countertop Ice Machine 20kg Output	15	AA234	Control Board(R134a)-new
T316 - Polar Countertop Ice Machine 20kg Output	15	AG871	Control Board(R600a)
T316 - Polar Countertop Ice Machine 20kg Output	18	AA237	Water Shower
T316 - Polar Countertop Ice Machine 20kg Output	20	AA239	Water Box
T316 - Polar Countertop Ice Machine 20kg Output	21	AA240	Evaporator Fixer
T316 - Polar Countertop Ice Machine 20kg Output	22	AA241	Rinsing Connector
T316 - Polar Countertop Ice Machine 20kg Output	23		Top Panel
T316 - Polar Countertop Ice Machine 20kg Output	24	AA129	Water Level Sensor
T316 - Polar Countertop Ice Machine 20kg Output	25	AA244	Water Temperature Sensor
T316 - Polar Countertop Ice Machine 20kg Output	30	AA249	Water Inlet head
T316 - Polar Countertop Ice Machine 20kg Output	31	AA250	Water Filling Tube
T316 - Polar Countertop Ice Machine 20kg Output	33	AA252	Alnico Magnet
T316 - Polar Countertop Ice Machine 20kg Output	36	AE947	Motor Connecting Axis AA119 (short axis)
T316 - Polar Countertop Ice Machine 20kg Output	70		Motor Guide
T316 - Polar Countertop Ice Machine 20kg Output	71		Tray Motor (with long axel)
T316 - Polar Countertop Ice Machine 20kg Output	37	AA256	Big Washer
T316 - Polar Countertop Ice Machine 20kg Output	38	AA257	Butterfly Shape Washer
T316 - Polar Countertop Ice Machine 20kg Output	40	AA115	Stopper
T316 - Polar Countertop Ice Machine 20kg Output	41	AA260	Diffused Device
T316 - Polar Countertop Ice Machine 20kg Output	42	AA261	Evaporator
T316 - Polar Countertop Ice Machine 20kg Output	43		Cabinet Liner
T316 - Polar Countertop Ice Machine 20kg Output	44	AA263	Magnet Valve
T316 - Polar Countertop Ice Machine 20kg Output	46	AA265	Water Inlet Valve
T316 - Polar Countertop Ice Machine 20kg Output	47	AA266	Water Valve Fixer
T316 - Polar Countertop Ice Machine 20kg Output	48	AA267	Filter Drier
T316 - Polar Countertop Ice Machine 20kg Output	49	AA268	Steel Grill
T316 - Polar Countertop Ice Machine 20kg Output	50		Left Panel
T316 - Polar Countertop Ice Machine 20kg Output	51		Grill
T316 - Polar Countertop Ice Machine 20kg Output	52	AA271	Compressor(R134a)
T316 - Polar Countertop Ice Machine 20kg Output	52	AG872	Compressor(R600a)
T316 - Polar Countertop Ice Machine 20kg Output	53	AA272	Condenser
T316 - Polar Countertop Ice Machine 20kg Output	54	AA273	Fan

T316 - Polar Countertop Ice Machine 20kg Output	56		Compressor Fixing Board
T316 - Polar Countertop Ice Machine 20kg Output	57	AA276	Feet
T316 - Polar Countertop Ice Machine 20kg Output	61	AB096	Rubber Foot
T316 - Polar Countertop Ice Machine 20kg Output	58	AA244	Ice Level Sensor
T316 - Polar Countertop Ice Machine 20kg Output	59	AA278	Ice Level Sensor Fixer
T316 - Polar Countertop Ice Machine 20kg Output	60	AA279	Ice Flopping Shelf
T316 - Polar Countertop Ice Machine 20kg Output	62	AE695	Water Inlet Pipe
T316 - Polar Countertop Ice Machine 20kg Output	63	AE941	Water Recycling Tube for TP-450
T316 - Polar Countertop Ice Machine 20kg Output	63	AM397	Water Recycling Tube for TP-600
T316 - Polar Countertop Ice Machine 20kg Output	64		Water Pump (Model:AP1200)
T316 - Polar Countertop Ice Machine 20kg Output	64	AA560	Pump (Model:TP-450)
T316 - Polar Countertop Ice Machine 20kg Output	65	AE943	Pump Connector for TP-450
T316 - Polar Countertop Ice Machine 20kg Output	65	AM398	Pump Connector for TP-600
T316 - Polar Countertop Ice Machine 20kg Output	66	AE944	Water Shower Cover
T316 - Polar Countertop Ice Machine 20kg Output	67	AE945	Hall Device
T316 - Polar Countertop Ice Machine 20kg Output	68	AE946	Motor Fixing Panel
T316 - Polar Countertop Ice Machine 20kg Output	69	AH060	Axis Cover
T316 - Polar Countertop Ice Machine 20kg Output	72	AL569	Back Panel
T316 - Polar Countertop Ice Machine 20kg Output	73	AN294	Power Cord
T316 - Polar Countertop Ice Machine 20kg Output	74	AE948	Drainage Tube
T316 - Polar Countertop Ice Machine 20kg Output	75	AE950	Waste Water Discharge Tube
T316 - Polar Countertop Ice Machine 20kg Output	76	AL321	Water Discharge Tri-Connector
T316 - Polar Countertop Ice Machine 20kg Output	77	AE950	Icing Water Discharge Tube
T316 - Polar Countertop Ice Machine 20kg Output	78		Wiring Tube
T316 - Polar Countertop Ice Machine 20kg Output	79	AL611	Drainage Cover
T316 - Polar Countertop Ice Machine 20kg Output	80	AE699	Seal Washer for Drainage Connector
T316 - Polar Countertop Ice Machine 20kg Output	81	AH061	Discharged Elbow Connector
T316 - Polar Countertop Ice Machine 20kg Output	82	AM294	Metal Bracket
T316 - Polar Countertop Ice Machine 20kg Output	83	AG101	Ambient Temp Sensor
T316 - Polar Countertop Ice Machine 20kg Output	84	AL341	Micro Switch
T316 - Polar Countertop Ice Machine 20kg Output	85	AL342	Micro Switch Board
T316 - Polar Countertop Ice Machine 20kg Output	86		Plastic Upper Fixing Board