

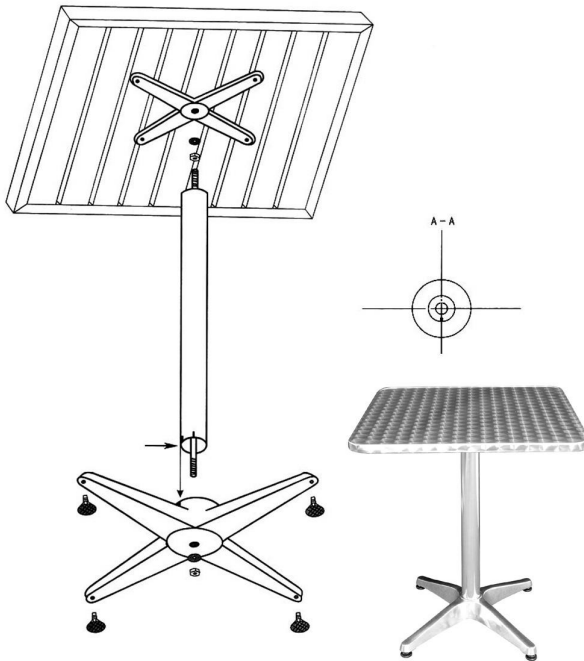











Code U427 & CG834:-

Stainless Steel Bistro Square Table

Assembly Instructions:-

BOLERO



	1 x Table Top
	1 x Aluminium Foot Base WITH:
	1 x Cast Iron Weight
	2 x Flat Washer
	2 x Hexagonal Nuts
	4 x Screw Feet Caps
	1 x Spanner
	1 x Hexagonal Nut Tightening Tool
	1 x Hexagonal Nut Tightening Tool
	1 x Rod
	2 x Spring Washer

Assembly instructions:

1. Thread a hexagonal nut onto one threaded end of the Rod with a spring washer to follow.
2. Place a flat washer over the hole on the metal spider on the underside of the table, and insert the threaded end of the rod
3. Turn the threaded rod until it securely grips into the metal spider on the underside of the table (do not tighten so much that the rod presses against the underside of the table itself)
4. Tighten the nut back down onto the unit using the spanner supplied
5. Place the aluminium tube over the threaded rod, ensuring that the end of the tube is securely positioned on the metal spider
6. Place the aluminium foot base over the end of the threaded rod, ensuring the notch at the bottom of the tube lines up with the lug on the table base (as shown in detail A-A)
7. Place a flat washer, spring washer and hexagonal nut on the end of the threaded rod and tighten using the socket spanner
8. Finally screw the feet caps to the Table foot base
9. Do not store upside down as this can cause water ingress

The Bolero Helpline telephone number is 0845 146 2887

Bolero, Fourth Way, Avonmouth, United Kingdom, BS11 8TB.

Code U427 & CG834:-

Vierkante RVS bistrotafel

Montage-instructies:

BOLERO

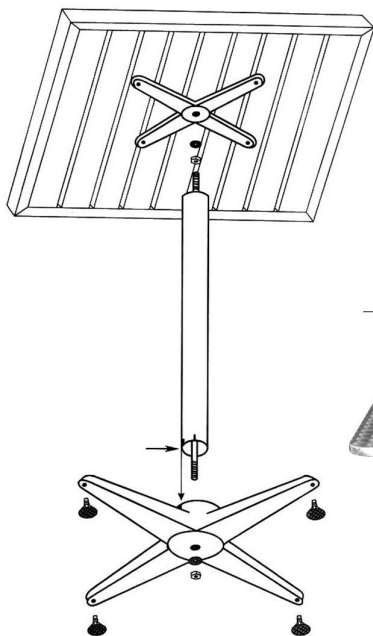

	1 x tafelblad
	1 x aluminium voetbasis MET:
	1 x gietijzergewicht
	2 x plat ringplaatje
	2 x zeskantmoeren
	4 x voetschroefdoppen
	1 x sleutel
	1 x sleutel voor zeskantmoeren
	1 x aluminium buis
	1 x stang
	2 x veerring

Montage-instructies:

1. Plaats een zeskantmoer op het schroefdraaduiteinde van de stang en plaats vervolgens een veerring.
2. Plaats een plat ringplaatje over de opening op de metalen spin aan de onderzijde van de tafel en plaats het schroefuiteinde van de stang
3. Draai de schroefstang totdat deze goed vastzit in de metalen spin aan de onderkant van de tafel (niet te vast aandraaien zodat de stang tegen de onderkant van de tafel zelf aandrukt)
4. Draai met behulp van de meegeleverde sleutel de moer omlaag vast op de unit
5. Plaats de aluminium buis over de schroefstang en zorg daarbij dat het uiteinde van de buis goed op de metalen spin is geplaatst
6. Plaats de aluminium voetbasis over het uiteinde van de schroefstang en zorg daarbij dat de inkeping van de buis uitgelijnd is met de pin van de tafelbasis (zoals afgebeeld in detail A-A)
7. Plaats een plat ringplaatje, een veerring en een zeskantmoer op het uiteinde van de schroefstang en gebruik de zeskantsleutel om deze aan te draaien
8. Als laatste schroeft u de voetdoppen op de voetbasis van de tafel
9. Niet ondersteboven opbergen want dan kan er water binnendringen

The Bolero Helpline telephone number is 0845 146 2887

Bolero, Fourth Way, Avonmouth, United Kingdom, BS11 8TB.









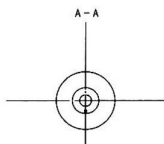
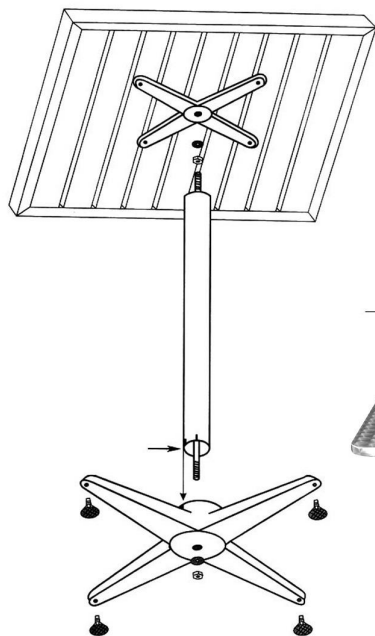

Code U427 et CG834 :-

Table Bistro carrée en acier inoxydable

Montage :-

BOLERO



	1 plateau de table
	1 pied en aluminium avec :
	1 lest en fonte
	2 rondelles plates
	2 écrous hexagonaux
	4 pieds à vis
	1 clé
	1 outil de serrage d'écrous hexagonaux
	1 tube en aluminium
	1 tige
	2 rondelles élastiques

Montage :

1. Placez un écrou hexagonal sur l'une des extrémités filetées de la tige, suivi d'une rondelle élastique.
2. Placez une rondelle plate sur le trou de la croix métallique située sur le dessous de la table et insérez-y l'extrémité filetée de la barre.
3. Tournez la tige filetée jusqu'à ce qu'elle soit bien fixée dans cette croix métallique (ne serrez pas trop pour que la tige ne touche pas le dessous de la table).
4. Serrez l'écrou du bas à l'aide de la clé fournie.
5. Placez le tube en aluminium sur la tige filetée, en veillant à ce que l'extrémité du tube soit bien positionnée dans la croix métallique.
6. Placez le pied en aluminium sur l'extrémité de la tige filetée en veillant à ce que l'encoche située au bas du tube soit bien alignée avec la barrette du pied de la table (comme illustré à la figure A-A).
7. Placez une rondelle plate, une rondelle élastique et un écrou hexagonal à l'extrémité de la tige filetée et serrez à l'aide de la clé à douille fournie.
8. Vissez les pieds sur la base de la table.
9. Ne pas entreposer à l'envers afin d'éviter toute entrée d'eau.

Le numéro de téléphone de la ligne d'assistance de Bolero est le 0845 146 2887.

Bolero, Fourth Way, Avonmouth, Royaume-Uni, BS11 8TB.









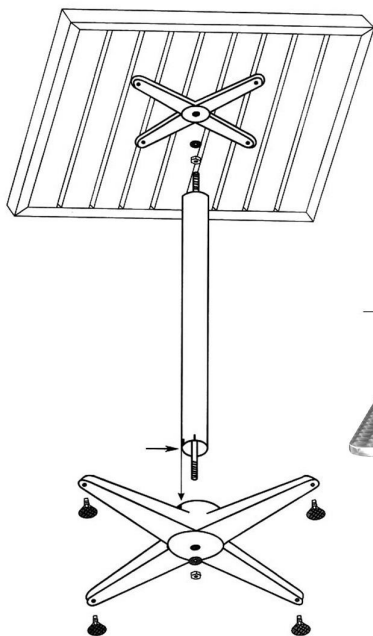

Code U427 & CG834:-

Quadratischer Edelstahl-Bistrotisch

Zusammenbau:

BOLERO



	1 Tischplatte
	1 Aluminium-Ständer MIT:
	1 Gusseisengewicht
	2 Unterleg-scheiben
	2 Sechskantmuttern
	4 Fußkappen zum Aufschrauben
	1 Schraubenschlüssel
	1 Sechskantmutter und Anzugsstift
	1 Alurohr
	1 Stange
	2 Federscheibe

Montageanleitung:

1. Eine Sechskantmutter auf das Gewindeende der Stange drehen und dann eine Federscheibe aufsetzen.
2. Eine flache Unterlegscheibe über den Metallstern auf der Tischunterseite legen und das Gewindeende des Stabs einführen.
3. Die Stange drehen, bis sie fest in den Metallstern an der Tischunterseite greift (nicht so sehr anziehen, dass die Stange gegen die Tischunterseite drückt).
4. Die Mutter mit dem Schraubenschlüssel im Lieferumfang in den Stern am Tisch drehen.
5. Das Aluminiumrohr über die Gewindestange führen. Dabei darauf achten, dass das Rohrende fest auf dem Metallstern sitzt.
6. Den Aluminiumständer über das Gewinde des Stabs führen. Dabei darauf achten, dass die Kerbe unten am Rohr auf einer Linie mit der Haltevorrichtung an der Tischunterseite ist (siehe Abb. A-A).
7. Eine Unterlegscheibe, Federscheibe und Sechskantmutter auf das Gewindeende der Stange legen und mit dem Steckschlüssel anziehen.
8. Anschließend die Fußkappen auf den Tischständer drehen.
9. Tisch nicht kopfüber lagern, da sonst Wasser eindringen könnte.

Telefonnummer für die Bolero-Helpline: +44 (0)845 146 2887

Bolero, Fourth Way, Avonmouth, BS11 8TB, Großbritannien.

Codice U427 e CG834:-

Tavolo bistrot quadrato in acciaio inox

Istruzioni di montaggio:-

BOLERO

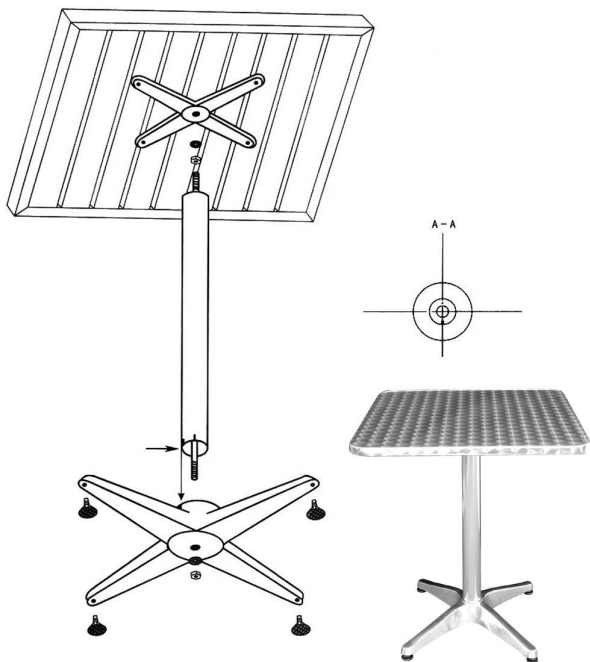

	Piano tavolo 1x
	Base alluminio 1 x CON:
	Peso in ghisa 1x
	Rondelle piatte 2x
	Dadi esagonali 2x
	Piedini 4x
	Chiave 1x
	Chiave a bussola 1x
	Tubo alluminio 1x
	Asta 1x
	Rondella elastica 2x

Istruzioni di montaggio:

1. Inserire un dado esagonale seguito da una rondella elastica su una estremità filettata dell'asta.
2. Posizionare una rondella piatta sul foro sul telaio di metallo sul lato inferiore del tavolo e inserire l'estremità filettata dell'asta.
3. Ruotare l'asta filettata fino a quando non prende saldamente nel telaio di metallo sul lato inferiore del tavolo (non serrare eccessivamente per non premere l'asta contro il lato inferiore del tavolo stesso).
4. Serrare il dado sull'unità utilizzando la chiave fornita.
5. Posizionare il tubo di alluminio sull'asta filettata, assicurandosi che l'estremità del tubo sia posizionata saldamente nel telaio di metallo.
6. Posizionare la base in alluminio sull'estremità dell'asta filettata, assicurandosi che l'intaglio alla base del tubo sia allineato con l'aletta della base del tavolo (come mostrato nella figura A-A).
7. Inserire una rondella piatta, una rondella elastica e un dado esagonale sull'estremità dell'asta filettata e serrare utilizzando la chiave a bussola.
8. Avvitare i piedini alla base del tavolo.
9. Il tavolo non deve essere immagazzinato capovolto in quanto può verificarsi l'ingresso di acqua.

Helpline telefonica Bolero: 0845 146 2887

Bolero, Fourth Way, Avonmouth, Regno Unito, BS11 8TB.









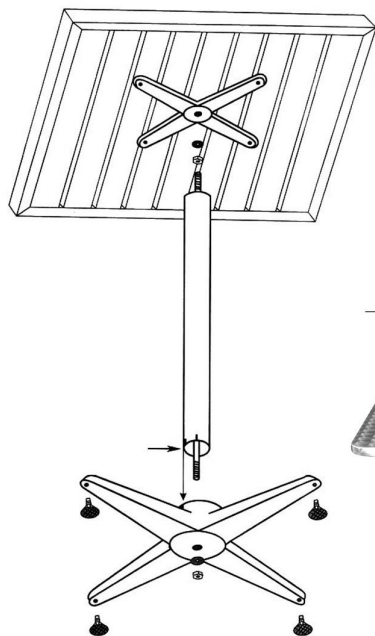

Código U427 y CG834:-

Mesa cuadrada de bistró de acero inoxidable

Instrucciones de montaje:-

BOLERO



	1 x Tablero de mesa
	1 x Base de pie de aluminio CON:
	1 x Lastre de hierro fundido
	2 x Arandelas planas
	2 x Tuercas hexagonales
	4 x Pies roscados
	1 x Llave de tuercas
	1 x Herramienta de apriete para tuercas hexagonales
	1 x Tubo de aluminio
	1 x Varilla
	2 x Arandela de resorte

Instrucciones de montaje:

1. Enrosque una tuerca hexagonal en un extremo roscado de la varilla seguida de una arandela de resorte
2. Ponga una arandela plana sobre el orificio de la cruceta metálica en la parte inferior de la mesa, e introduzca el extremo roscado de la varilla
3. Gire la varilla roscada hasta que esté sujeta de forma segura a la cruceta metálica de la parte inferior de la mesa (no la apriete tanto como para que la varilla esté presionada contra la parte inferior de la propia mesa)
4. Vuelva a apretar la tuerca hacia abajo sobre la unidad utilizando la llave suministrada
5. Ponga el tubo de aluminio sobre la varilla roscada, asegurándose de que el extremo del tubo esté colocado de forma segura en la cruceta metálica
6. Sitúe la base de pie de aluminio sobre el extremo de la varilla roscada, asegurándose de que la muesca de la parte inferior del tubo se alinee con la agarradera en la base de la mesa (como se muestra en el detalle A-A)
7. Sitúe una arandela plana, una arandela de resorte y una tuerca hexagonal en el extremo de la varilla roscada y apriételas utilizando la llave de cubo
8. Por último, atornille los pies a la base de pie de la mesa
9. No almacenar al revés, ya que podría entrar agua

El número de asistencia telefónica de Bolero es el +44 (0) 0845 146 2887

Bolero, Fourth Way, Avonmouth, Reino Unido, BS11 8TB.

Código U427 e CG834:

Mesa quadrada de café em aço inoxidável

Instruções de montagem:

BOLERO

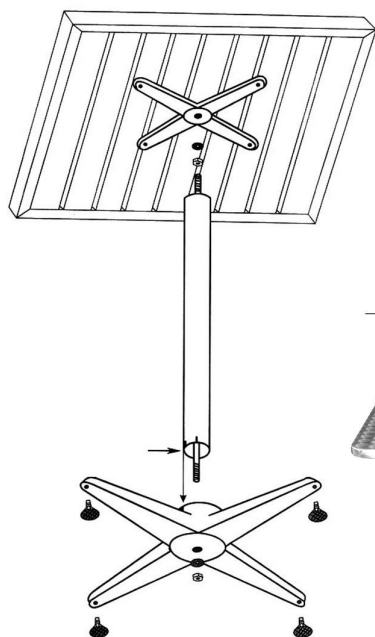

	1 x Tampa de mesa
	1 x Base de suporte de alumínio:
	1 x Peso em ferro fundido
	2 x Anilhas planas
	2 x Porcas hexagonais
	4 x Tampas de enroscar para as pernas
	1 x Chave
	1 x Ferramenta de aperto para as porcas hexagonais
	1 x Tubo de alumínio
	1 x Barra
	2 x Anilhas de mola

Instruções de montagem:

1. Enrosque uma porca hexagonal num dos extremos roscados da barra e, de seguida, coloque uma anilha de mola.
2. Coloque uma anilha plana no orifício da aranha metálica no lado posterior da mesa e introduza o extremo roscado da barra.
3. Rode a barra roscada até ficar firmemente fixa à aranha metálica no lado posterior da mesa (não aperte demasiado para evitar que a barra exerça pressão por si mesma no lado posterior da mesa)
4. Volte a enroscar a porca na unidade utilizando a chave fornecida.
5. Coloque o tubo de alumínio por cima da barra roscada, certificando-se de que o extremo do tubo esteja posicionado firmemente na aranha metálica.
6. Coloque a base de suporte de alumínio por cima do extremo da barra roscada, certificando-se de que o entalhe do extremo do tubo esteja alinhado com o engate da base da mesa (conforme mostrado em detalhe em A-A)
7. Coloque uma anilha plana, uma anilha de mola e uma porca hexagonal no extremo da barra roscada e aperte utilizando a chave fornecida.
8. Por último, enrosque as tampas das pernas na base de suporte da mesa.
9. Não guarde a mesa virada para baixo para evitar a entrada de água.

O número de assistência da Bolero é 0845 146 2887

Bolero, Fourth Way, Avonmouth, Reino Unido, BS11 8TB.