









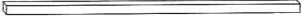

GG498

Vogue Gastronorm 1/1 Racking

Trolley (7 Level)



Model GG498

Parts	No	Qty
	P1	2
	P2	1
	P3	2
	P4	8
	P5	8
	P6	4
	P7	4
	P8	2
	P9	2
	P10	1

Assembling

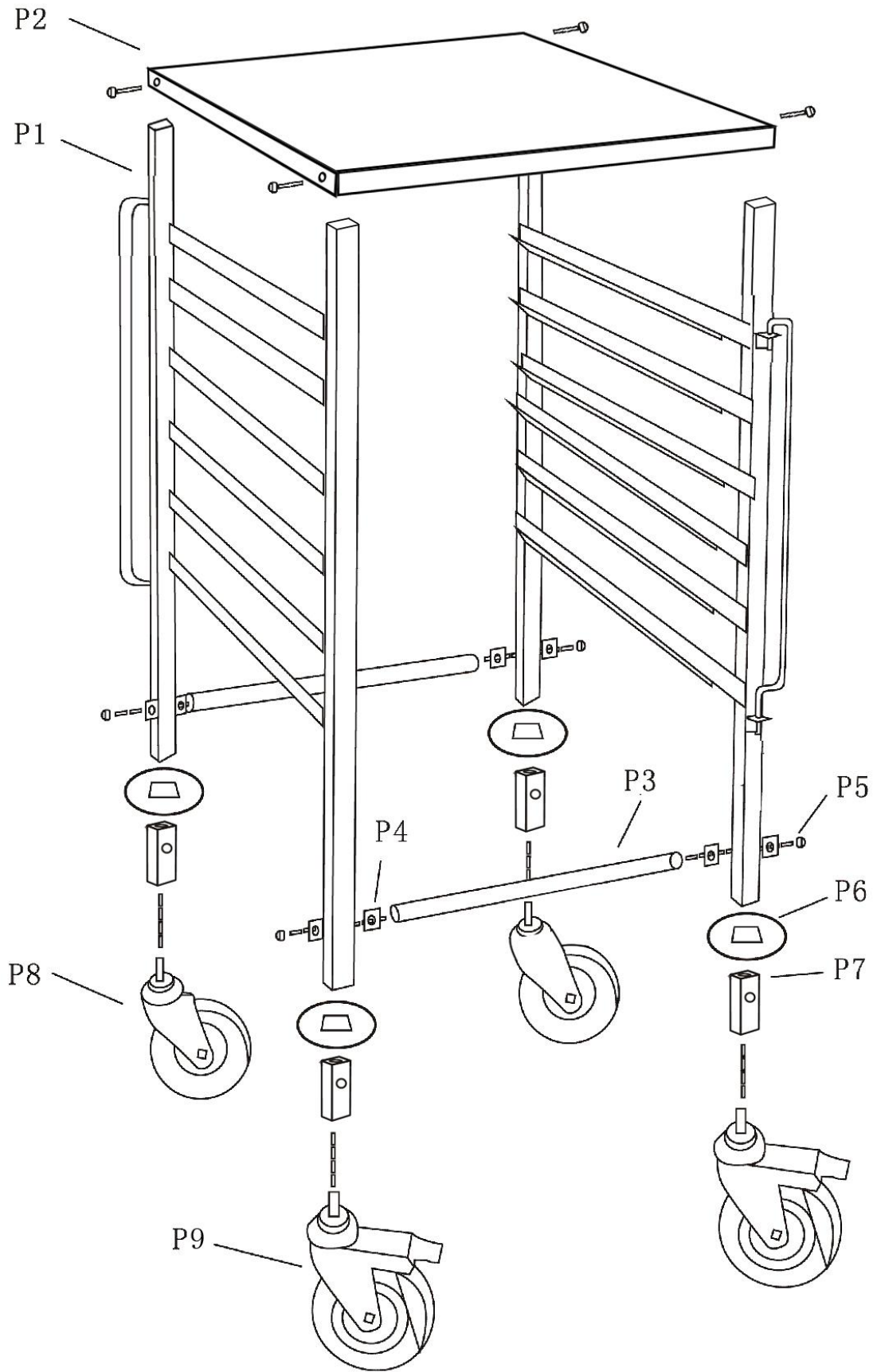

Instructions

Safety instructions

- Do not place more heavy items on the top levels than on the lower levels
- Do not climb on the trolley

Assembly

- Install 4 x bumpers [P6] and 4 x castors [P8] & [P9] with 4 x sleeves [P7] on side frames [P1], two braked castors will be screwed in front of side frames.
- Connect the two side frames [P1] with 2 x rectangular bars [P3], fix the rectangular bars [P3] together with 8 x square gaskets [P4] and supplied 4 x screws [P5] to the other Side Frame.
- Using 4 x screws [P5] fix the Top part [P2] with the two side frames [P1].

Cleaning and maintenance

- Clean the trolley using warm soapy water
- Dry the trolley thoroughly after cleaning it.