























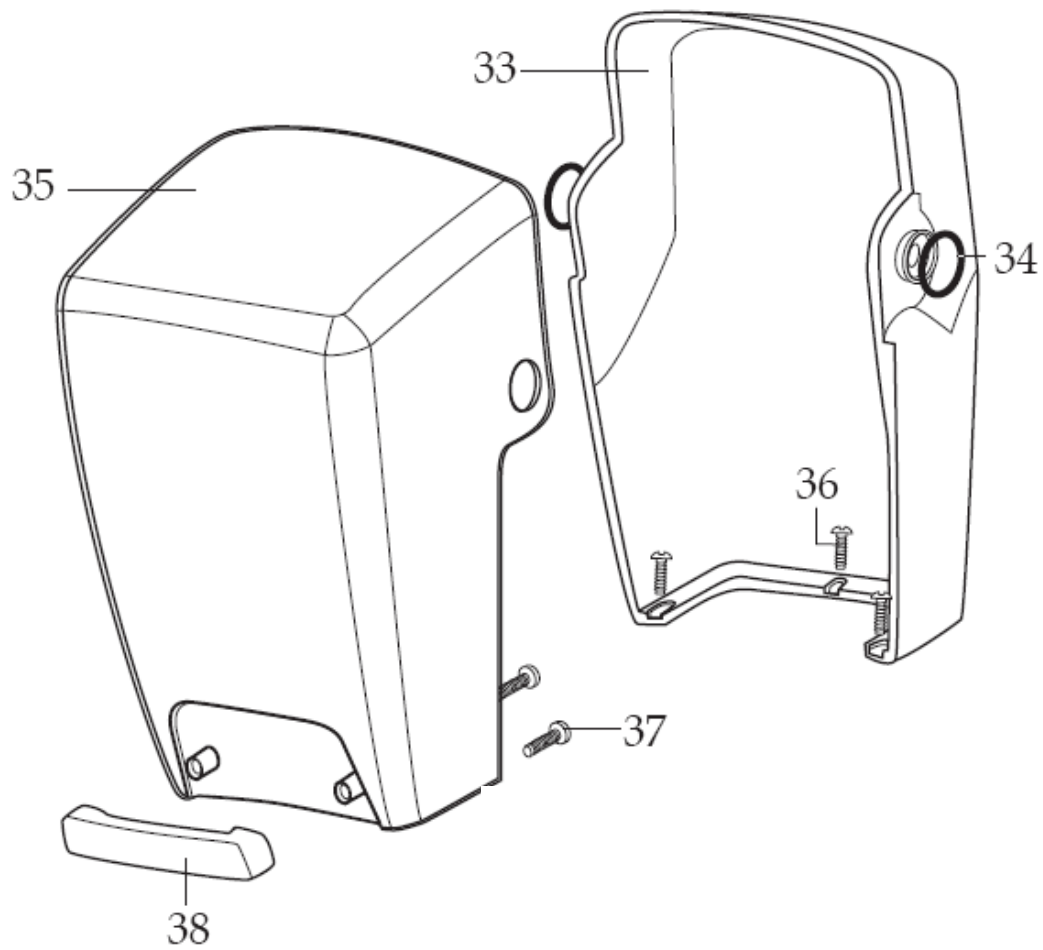

| Machine                        | Explode | Code  | Description   |
|--------------------------------|---------|---|---|
| Waring Xtreme Hi-Power Blender |         | DM876   | WARING STACKING MX JAR  |
| Waring Xtreme Hi-Power Blender |         | AC900   | STACKABLE POLYCARBONATE CONTAINER WITH LID - 48OZ                         |
| Waring Xtreme Hi-Power Blender | 1       | See   | JAR LID COVER   |
| Waring Xtreme Hi-Power Blender | 2       |   | JAR LID   |
| Waring Xtreme Hi-Power Blender | 3       | DM876   | JAR ONLY / 64 OZ. STACKABLE<br>JAR WITH BLENDING ASSY. / 64 OZ. STACKABLE |
| Waring Xtreme Hi-Power Blender | 4       |    | BLADE ASSY.   |
| Waring Xtreme Hi-Power Blender | 5       |    | BEARING HOLDER O RING   |
| Waring Xtreme Hi-Power Blender | 6       |    | NUT GASKET  |
| Waring Xtreme Hi-Power Blender | 7       |    | BEARING HOLDER NUT  |
| Waring Xtreme Hi-Power Blender | 8       | AC930   | DRIVE CLUTCH  |
| Waring Xtreme Hi-Power Blender | 9       |    | JAR PAD   |
| Waring Xtreme Hi-Power Blender | 10      |    | JAR PAD/ SOUND ENCLOSURE  |
| Waring Xtreme Hi-Power Blender | 11      | AC931   | MOTOR   |
| Waring Xtreme Hi-Power Blender | 12      | AC932   | DAMPENING PLATE GASKET  |
| Waring Xtreme Hi-Power Blender | 13      |    | TOP HOUSING / BLACK   |
| Waring Xtreme Hi-Power Blender | 14      |    | MOTOR FOAM 2 REQ.'D   |
| Waring Xtreme Hi-Power Blender | 15      |    | DAMPENING PLATE BUSHING 4 REQ.'D  |
| Waring Xtreme Hi-Power Blender | 16      |    | DAMPENING PLATE SLEEVE 4 REQ.'D   |
| Waring Xtreme Hi-Power Blender | 17      |    | WASHER 2 REQ.'D   |
| Waring Xtreme Hi-Power Blender | 18      |    | SCREW 4 REQ.'D  |
| Waring Xtreme Hi-Power Blender | 19      | AC933   | CONTROL PANEL   |
| Waring Xtreme Hi-Power Blender | 20      |    | HOUSING FOAM BAFFLE / REAR  |
| Waring Xtreme Hi-Power Blender | 21      |    | HOUSING FOAM BAFFLE / FRONT   |
| Waring Xtreme Hi-Power Blender | 22      |   | MOTOR HOUSING   |
| Waring Xtreme Hi-Power Blender | 23      |  | WASHER 3 REQ.'D   |
| Waring Xtreme Hi-Power Blender | 24      |  | BOTTOM HOUSING FOAM BAFFLE  |
| Waring Xtreme Hi-Power Blender | 25      |  | FOAM BAFFLE   |
| Waring Xtreme Hi-Power Blender | 26      |  | CABLE TIE 3 REQ.'D  |
| Waring Xtreme Hi-Power Blender | 27      | AC934   | CORD SET  |
| Waring Xtreme Hi-Power Blender | 28      |  | STRAIN RELIEF   |
| Waring Xtreme Hi-Power Blender | 29      |  | BOTTOM HOUSING / BLACK  |
| Waring Xtreme Hi-Power Blender | 30      | AC938   | SCREW 4 REQ.'D  |
| Waring Xtreme Hi-Power Blender | 31      |  | CORNER POST 4 REQ.'D  |
| Waring Xtreme Hi-Power Blender | 32      |  | SCREW 4 REQ.'D  |
| Waring Xtreme Hi-Power Blender | 503392  |  | SPANNER WRENCH (OPTIONAL)   |
| Waring Xtreme Hi-Power Blender | 503351  |  | MX COUPLING WRENCH (OPTIONAL)   |



|                                |    |       |                                |
|--------------------------------|----|-------|--------------------------------|
| Waring Xtreme Hi-Power Blender | 33 | ☎     | INNER SOUND ENCLOSURE / SE1000 |
| Waring Xtreme Hi-Power Blender | 34 | ☎     | "O" RING 2 REQ.'D              |
| Waring Xtreme Hi-Power Blender | 35 | ☎     | OUTER SOUND ENCLOSURE / SE1000 |
| Waring Xtreme Hi-Power Blender | 36 | AC937 | SCREW 3 REQ.'D                 |
| Waring Xtreme Hi-Power Blender | 37 | AC938 | SCREW 2 REQ.'D                 |
| Waring Xtreme Hi-Power Blender | 38 | AC939 | SOUND ENCLOSURE HANDLE         |